

292/600

Dimensions

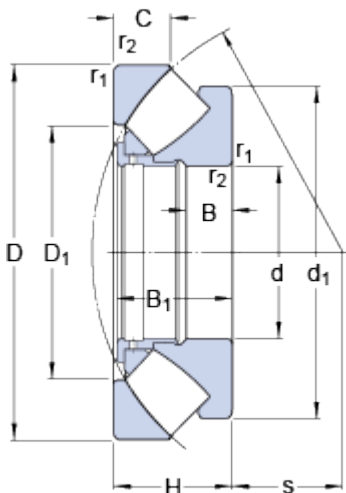

d	600	mm
D	800	mm
H	122	mm
d ₁	≈ 760	mm
D ₁	≈ 688	mm
B	39	mm
B ₁	117	mm
C	60	mm
s	321	mm
r _{1,2}	min. 5	mm

Abutment dimensions

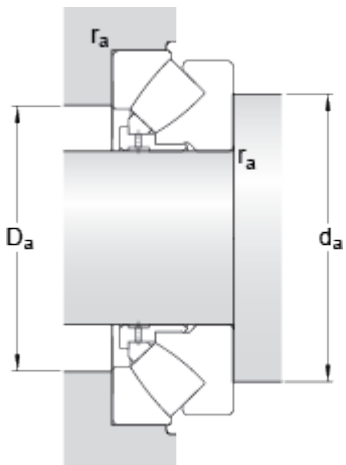

d _a	min. 700	mm
D _a	max. 735	mm
r _a	max. 4	mm

Calculation data

Basic dynamic load rating	C	3740	kN
Basic static load rating	C ₀	18600	kN
Fatigue load limit	P _u	1460	kN
Reference speed		450	r/min
Limiting speed		700	r/min
Minimum axial load factor	A	33	

Mass

Mass bearing		170	kg
--------------	--	-----	----